

SOLAR SECTION

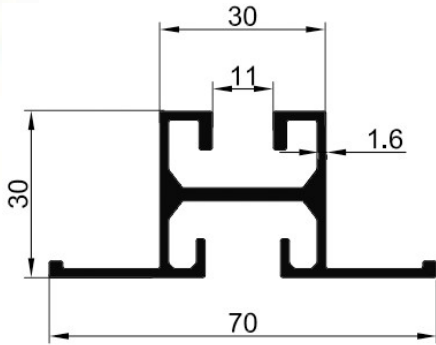

SI NO	SECTION NO.	WEIGHT(KG/M)
1	6405	0.916

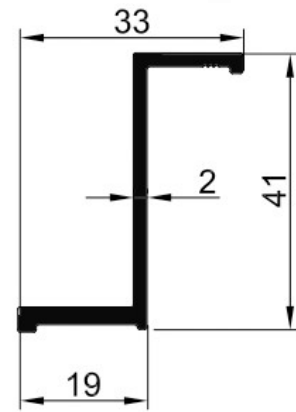

SI NO	SECTION NO.	WEIGHT(KG/M)
1	6406	0.426

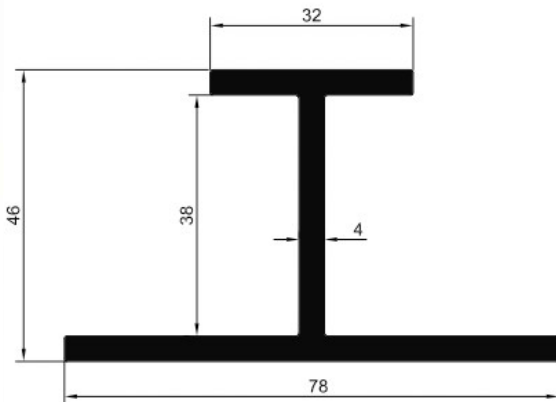

SI NO	SECTION NO.	WEIGHT(KG/M)
1	9100	1.597

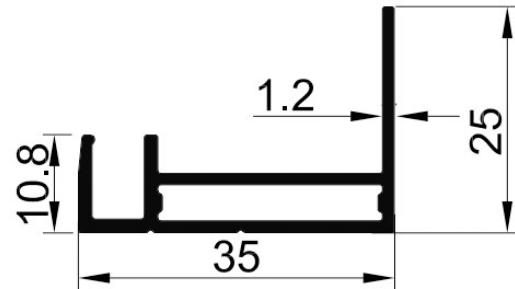

SI NO	SECTION NO.	WEIGHT(KG/M)
1	9151	0.329

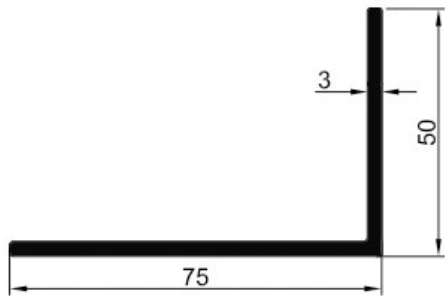

SI NO	SECTION NO.	WEIGHT(KG/M)
1	9155	0.988

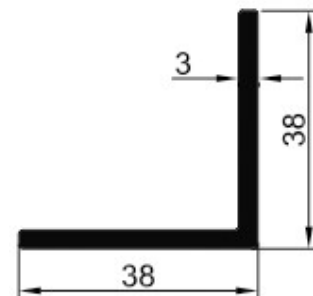

SI NO	SECTION NO.	WEIGHT(KG/M)
1	9153	0.590

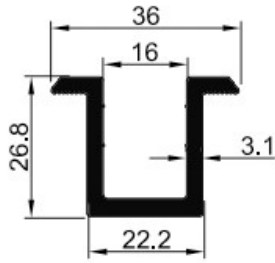

SI NO	SECTION NO.	WEIGHT(KG/M)
1	9157	0.703

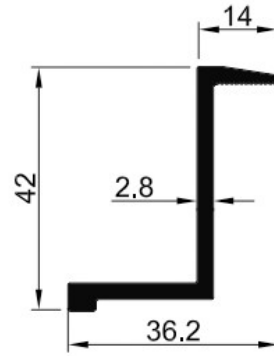

SI NO	SECTION NO.	WEIGHT(KG/M)
1	9159	0.564

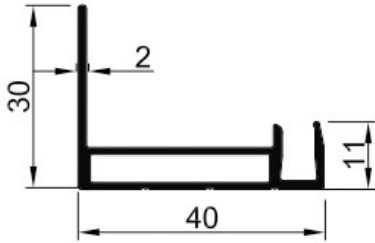

SI NO	SECTION NO.	WEIGHT(KG/M)
1	9163	0.400

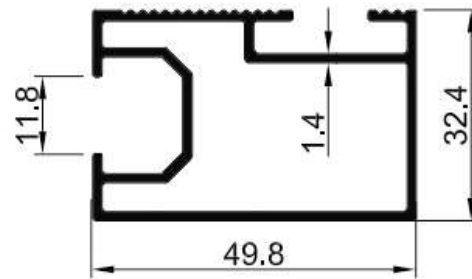

SI NO	SECTION NO.	WEIGHT(KG/M)
1	9161	0.791

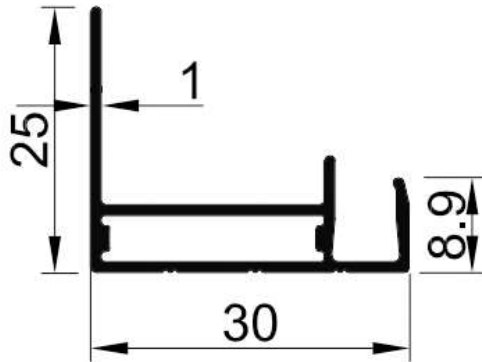

SI NO	SECTION NO.	WEIGHT(KG/M)
1	9165	0.258

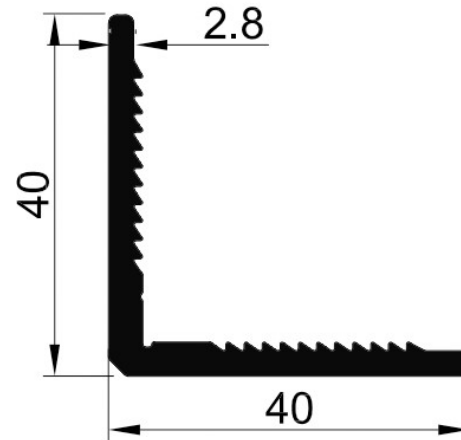

SI NO	SECTION NO.	WEIGHT(KG/M)
1	9167	0.681

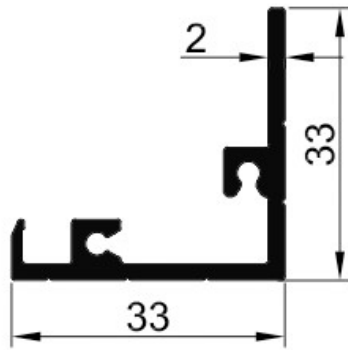

SI NO	SECTION NO.	WEIGHT(KG/M)
1	9170	0.478

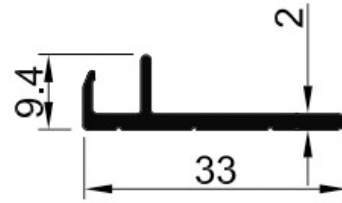

SI NO	SECTION NO.	WEIGHT(KG/M)
1	9172	0.212

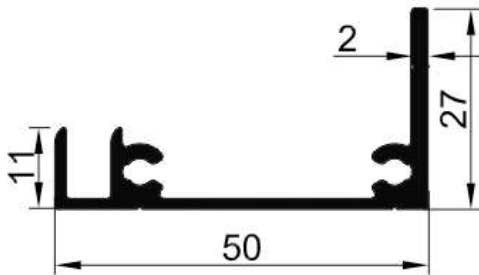

SI NO	SECTION NO.	WEIGHT(KG/M)
1	9174	0.551

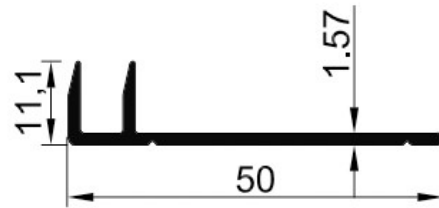

SI NO	SECTION NO.	WEIGHT(KG/M)
1	9176	0.277

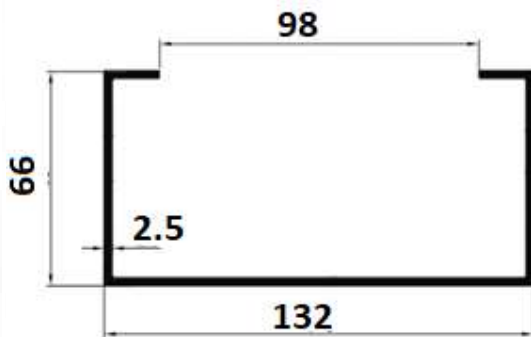

SI NO	SECTION NO.	WEIGHT(KG/M)
1	9180	1.944

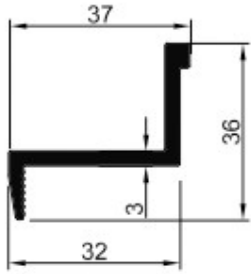

SI NO	SECTION NO.	WEIGHT(KG/M)
1	9182	0.560

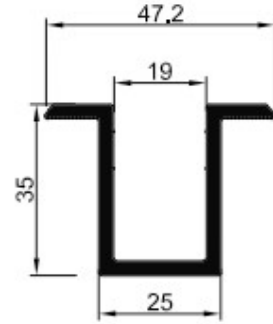

SI NO	SECTION NO.	WEIGHT(KG/M)
1	9184	0.883

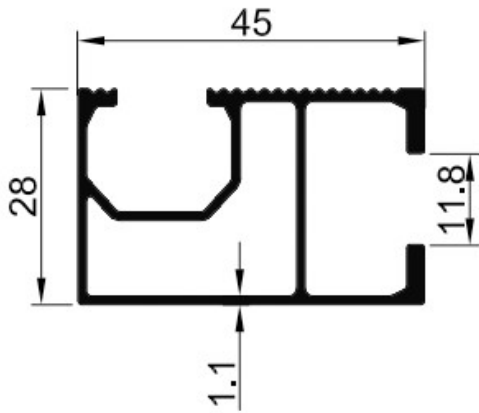

SI NO	SECTION NO.	WEIGHT(KG/M)
1	9186	0.623

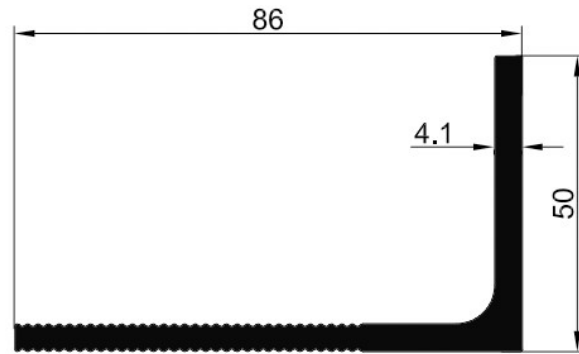

SI NO	SECTION NO.	WEIGHT(KG/M)
1	9188	1.611

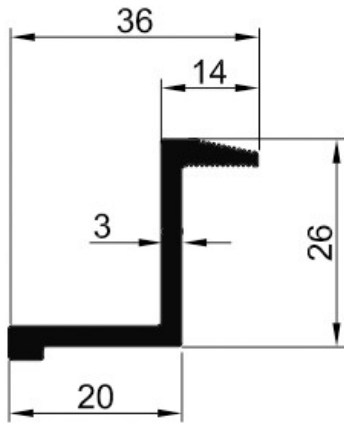

SI NO	SECTION NO.	WEIGHT(KG/M)
1	9411	0.534

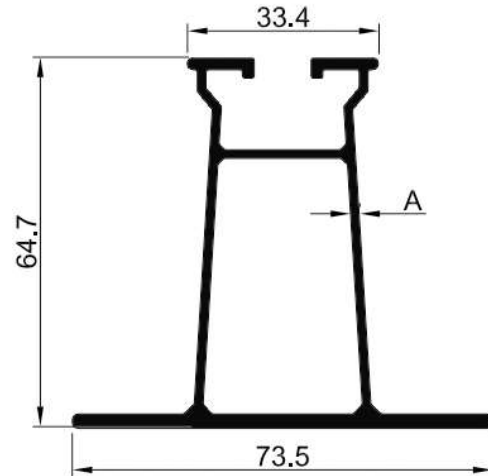

SI NO	SECTION NO.	A	WEIGHT(KG/M)
1	9413	1.5	1.242
2	9414	1.2	0.992